

front view

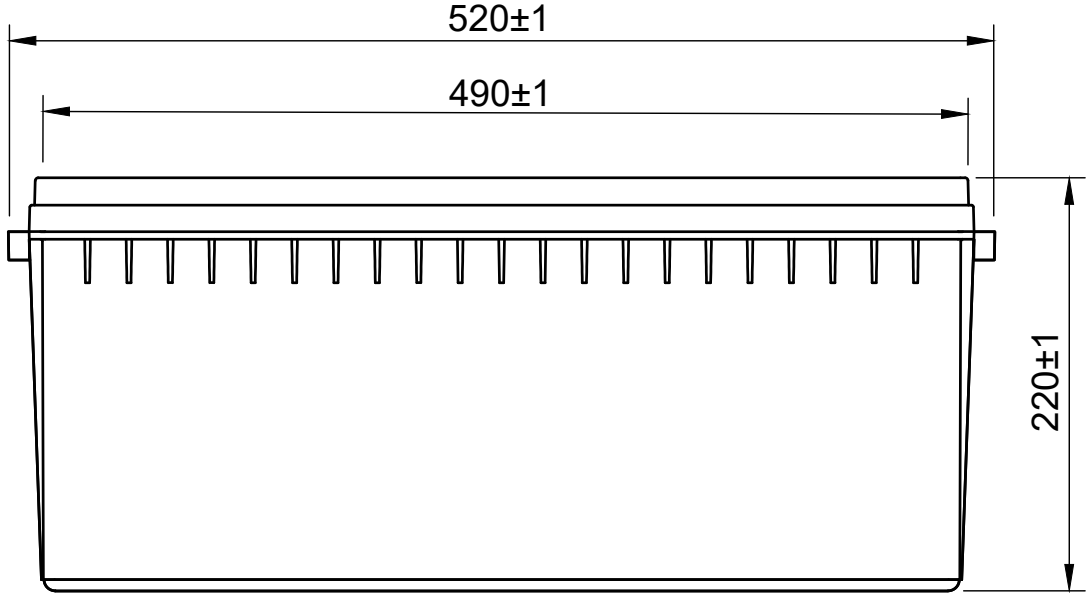

side view

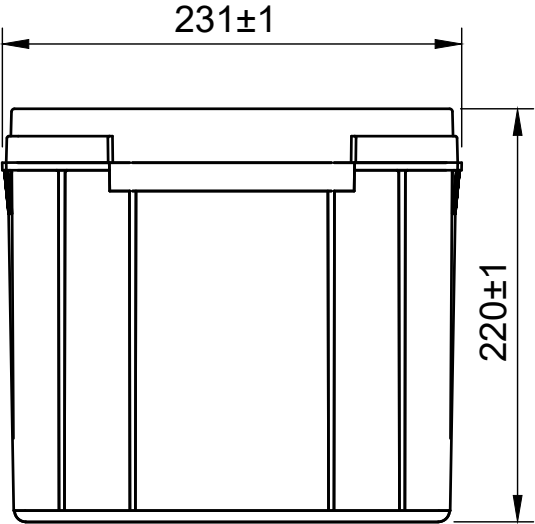

Dept.	Technical reference	Created by NH	12.02.2024	Approved by
		Document type	Document status	
		Title 2-01-017320	DWG No.	
		Rev.	Date of issue	Sheet 1/2

top view

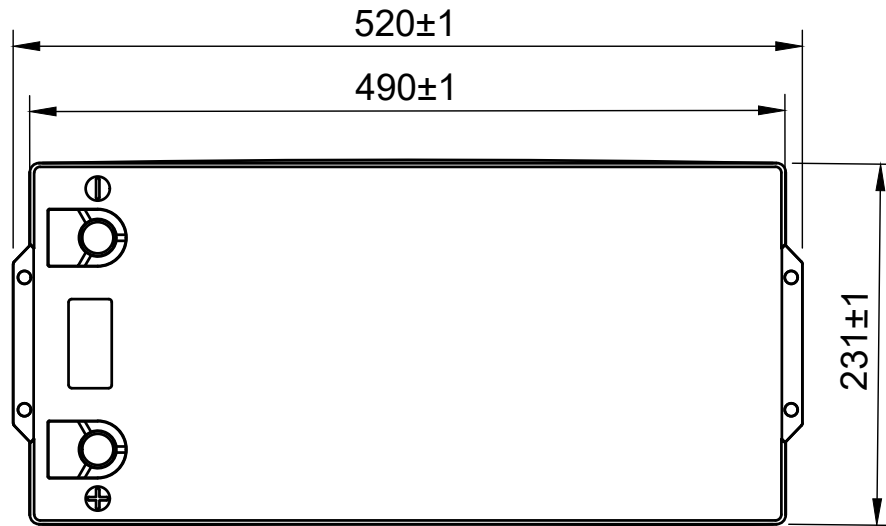

bottom view

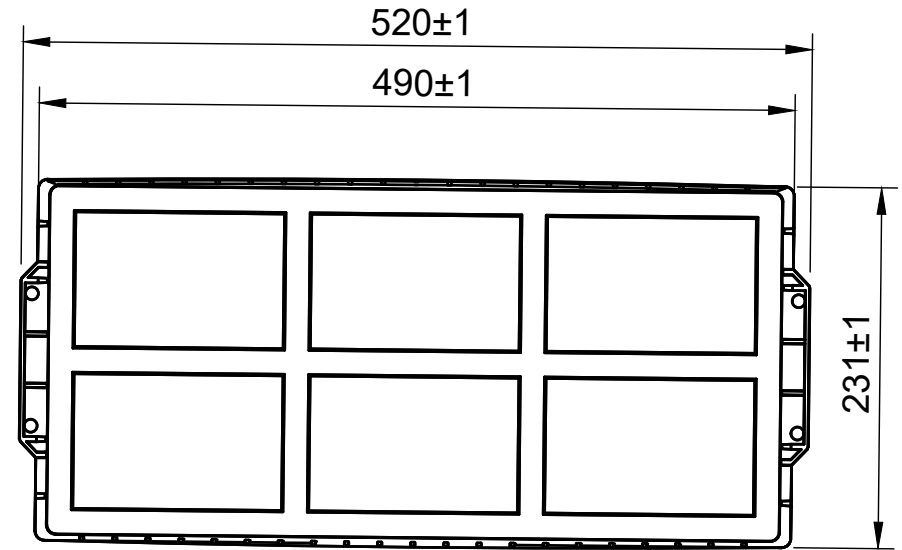

Dept.	Technical reference	Created by NH	12.02.2024		Approved by
		Document type	Document status		
		Title 2-01-017320	DWG No.		
		Rev.	Date of issue	Sheet 2/2	